

Other CruzPro Products

- Depthsounders, Fishfinder & Speed/Temperature/Log
- DC Volts/Amps/Amp-Hour Monitors
- AC Volts/Amps/Freq/kW Monitor
- LPG/Petrol Gas Detectors/Alarms
- Bilge Water Alarms & Bilge Pump Controllers
- Windlass Controller/Chain Counter
- Digital Fuel Gauges & Fuel Consumption Calculator
- Digital Gauge for 1 or 3 Tanks /w Separate Alarms
- Smart 4 step Alternator Regulator
- Marine Security System/w Reliable Intrusion Sensors
- RPM/Engine Hours/Elapsed Time Gauge/w Alarm
- Digital Oil Pressure Gauge/Alarm
- Digital Temperature Gauges for 1 or 3 Areas /w Alarms
- One and Three Bank Digital Volts Gauges
- Digital Amps Gauge
- Digital Clock/Watch/Race Timers/w 8 Alarms
- 8 and 16 Amp Light Dimmers / Motor Speed Controller
- Solar Panel Charge Controllers 6/8/9 & 20 Amps
- 4 & 8 Channel NMEA Combiners/RS-232 Convertors
- Engine/Exhaust Temp. Monitor & Digital Pyrometer
- NMEA 0183 Remote Data Repeater/w 4 Input Channels

CruzPro®



T60



Engine Water Temperature Gauge/w Alarms

Notes and Warnings

- When setting calibration functions that require you to hold down a key while applying power to the T60 - be sure to turn OFF the power first, then hold the key(s) down during and for at least 3 seconds AFTER the power has been applied to insure the computer has read the keys.
- If the sender temperature is below the minimum temperature where manufacturer's calibration data is available, the T60 displays "LO".
- If the sender temperature is above the maximum temperature where manufacturer's calibration data is available, the T60 displays "HI".

Introduction

The T60 Temperature Gauge displays water or engine oil temperature in degrees F or C. It has built-in calibration curves for most popular senders manufactured by VDO, Teleflex, Stewart-Warner and others (senders available separately). Sender type is selected with the front panel keys. Low and High temperature alarms can be set over the entire range of the instrument/sender. When activated, the built-in alarm will sound and the display will flash. The alarms can be enabled or disabled with a single key press. Five levels of backlighting can be selected and all setup, calibration constants, alarm values, and sender type is saved to nonvolatile memory. NMEA 0183 compatible serial data is output on screw terminal C. If NMEA 0183 is not required, screw terminal C can be programmed as an external alarm output.

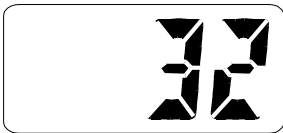

Press the UP and DOWN keys to set the desired low temperature alarm limit. Press the "+" key to save your entry.

Calibrating the Instrument

Press and hold the  key for 10 seconds to enter the Temperature Calibration mode. Press the UP and DOWN keys to adjust the display to read the correct temperature. Press the "+" key to save the calibration information. Calibration is usually not required if the correct sender type is selected.

Page 12

Installation

Before starting the installation, please read this entire section first. Be sure to install the bulkhead gasket before you install the instrument. Finger tighten the screws that mount the instrument bracket - do not use tools.

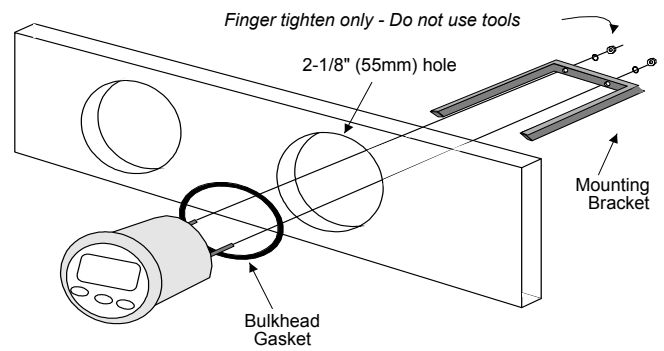



Figure 1

Page 5

- U-1 : VDO Ver 1
- U-2 : VDO Ver 2
- U-3 : VDO Ver 5 or VDO #320.720
- U-4 : Teleflex/Stewart-Warner
- U-5 : Cyberdyne

Selecting Degrees F or Degrees C Display

Press and hold the  key for three seconds while applying power to the instrument. This toggles between degrees F and degrees C display.

driver to make the connections to the screw terminal on the instrument case back as shown in figure 2.

- Carefully check all your wiring against those shown in figure 2. If everything is wired correctly you can mount the T60 in the instrument hole. Be sure the bulkhead gasket is in place and use only fingertension to tighten the bracket hold-down nuts *Do not overtighten the bracket or you may damage the case - do not use tools to tighten the nuts.*

Page 10

Page 7

Mounting and Wiring

- Drill a 2-1/8" (54mm) mounting hole where you desire to mount the instrument (Figure 1).
- Bring the sender wires, ground, and power lines out of the mounting hole and use a small flat screw

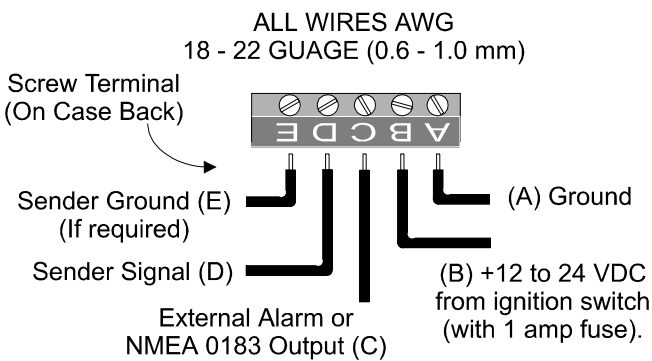

Page 6

Figure 2

Setting High Temperature Alarm

While viewing the temperature, press and hold the key for ten (10) seconds. You will hear a long beep and see the display as shown. Press the UP and DOWN keys to set the desired high temperature alarm limit. Press the "+" key to save your entry.

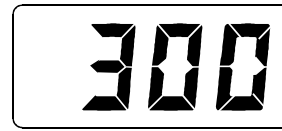

Setting Low Temperature Alarm

While viewing the temperature, press and hold the key for ten (10) seconds. You will hear a long beep and see the display as shown.

Page 11

Operation

Key Functions

The keys are used to select backlight levels, units of measure (deg F or deg C), temperature sender type, calibrate the instrument, set low and high temperature alarms and activate/deactivate the alarms. After changes are made, the new information is automatically saved to memory.

Backlight Intensity

Press the key for 1/2 second to adjust the backlight level for nighttime viewing. Each time you press the "+" key for 1/2 second, the level will get brighter 1, 2, 3, 4, OFF, 1, 2, ... etc.

Page 8

Alarms ON/Off

Press the or keys for 1/2 second to "arm" and "disarm" the alarms. When the alarms are armed a flag is displayed in the lower left corner as shown:

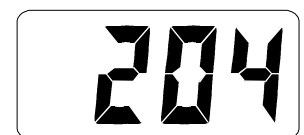

Selecting Sender Type

Press and hold the key and apply power to the instrument. You will see this display: Press any key to change to U-2, U-3 etc. Select the sender type from the table below. Press the "+" key to save your selection.

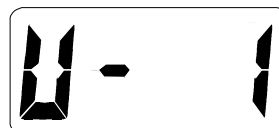

Page 9